



Product Catalog

WE DESIGN, MANUFACTURE, SERVICE, SELL AND RENT.

godwin 
a xylem brand



About Us

Xylem is the world leader in manufacturing tough, portable and reliable pumps. We are fully dedicated to delivering pumping solutions for our customers, with more than 100 years of heritage behind our Godwin brand. We design, manufacture, service, sell and rent products that are efficient, reliable and targeted to the specific needs of our customers. Our rental fleet, world-class application engineering, and proven 24/7 service and support are ready to meet your emergency pumping needs. All of the products in our catalog are available for rent.

Table of Contents

4 OUR EXPERTISE

Manufacturing

Engineering

24/7 Rental, Parts & Service

Maintenance & Support

8 GODWIN DRI-PRIME®

Automatic Self-Priming Pumps

How Dri-Prime® Works

Quiet & Protected

Features & Benefits

12 GODWIN DRI-PRIME DIESEL DRIVE

CD Series

*High Volume, Medium-Head, Large
Solids-Handling Capabilities*

HL Series

*High-Head and Jetting Pumps with
Solids-Handling Capabilities*

NC Series

Featuring Flygt N-technology

18 GODWIN DRI-PRIME ELECTRIC DRIVE

CD Series

*High Volume, Medium-Head, Large
Solids-Handling Capabilities*

HL Series

*High-Head and Jetting Pumps with
Solids-Handling Capabilities*

NC Series

Featuring Flygt N-technology

23 DRI-PRIME BACKUP SYSTEM (DBS™)

24 SUBMERSIBLE PUMPS

Godwin Heidra® Submersible Pumps
Hydraulic Submersible Pumps

Godwin Sub-Prime®
Hydraulic Submersible Pumps

28 WELLPOINT PUMPS

Construction Dewatering Systems

MV Series

Rotary Lobe

32 WET-PRIME PUMPS

Construction Dewatering Systems

34 MONITORING & CONTROL EQUIPMENT

35 LIGHT TOWERS

36 POWER GENERATORS

38 GENUINE SPARE PARTS KIT

39 MECHANICAL ACCESSORIES

Accessories

Hose

Quick Disconnect Couplings
& Adapters



Manufacturing

We design, manufacture, and service Godwin pumps in our facilities around the world.

Xylem's flexible manufacturing process allows for fast turnaround of equipment, designed and built to your specifications.

Godwin pump-ends have an interchangeable footprint that allows for streamlined assembly. The precision of each pump component enables us to have the world's most readily available range of pumps for rental and sale.



Engineering & Expertise

For over a century, Xylem's well-known global brands have served the water market. We offer deep applications expertise from decades of leading innovation with products, systems and services that address your needs. When you choose Xylem, you have our experienced people on your side from start to finish.

Our engineers ensure that you have the right equipment for your job, whether it's disaster recovery, routine site drainage or a large, complex sewer bypass project. Population growth and rapid urbanization has led to an increase in home and industry water use. As a result, aging infrastructure is under enormous strain. Working in true partnership with our customers, our engineers listen, learn and adapt to local environments, delivering solutions with more impact than ever before.

Our Engineers will:

- Utilize the most current tools to design and engineer everything from new pump models to large-scale or highly-complex pump systems.
- Design pumping systems specific to your application.
- Provide technical proposals.
- Provide relevant engineering experience to design the best solution for you regardless of where you are in the world.



24/7 Rental, Parts & Service



1•800•24PUMP4

Emergencies don't work a 9-to-5 schedule, and neither do we. Xylem is available to you whenever you call with the right pumps and equipment available for rent 24/7. We maintain the industry's largest inventory, including spare parts and accessories for production models.

When you call any one of our branches after business hours, you will get access to one of our field technicians – 24 hours a day, 7 days a week.

You can rent best-in-class pumping equipment and have access to our skilled engineers, product experts and service technicians to keep your operations running.

In addition, each service truck carries a standard parts inventory, so we can deploy immediately and service pumps wherever and whenever needed.

Onsite Services

When you need assistance in the field, we provide the support you need to keep everything moving.

OUR ONSITE SERVICES INCLUDE:

- 24/7 Service
- Branch Capabilities
- Design & Consultancy
- Installation & Commissioning
- Maintenance Contracts
- Monitoring & Supervision
- Parts & Logistics
- Pump Rental & Services
- Repair & Maintenance
- Training & Technical Support

You are just a call or click away from assistance with any issues you may encounter on site.



Maintenance & Support

We stand by our products and pride ourselves on reliability and responsiveness. In-house and field technicians conduct preventative maintenance and service for our extensive rental fleet. We extend these same services to you.

Xylem is available to serve you around the clock. Our service and sales staff is on call 24/7 to meet your emergency pumping needs whenever and wherever they occur.

OUR 24/7 SUPPORT INCLUDES:

- Application setup and tear down
- Equipment rental
- HDPE pipe fusion
- Maintenance
- Pump watch
- Repairs
- Parts and equipment deliveries



LOOKING FOR FAST, CONVENIENT, GENUINE GODWIN PARTS?

Find them on **Page 38**

We also provide on-site fusion technicians to fuse HDPE pipe up to 36 inches in diameter.

Whenever you need us, whether for scheduled service or emergency calls, Xylem will be there with the spare equipment, parts and services you need.



How Dri-Prime[®] Works

The secret to the reliability of Godwin Dri-Prime pumps is the automatic self-priming system.

Compressed air (1) travels through the Godwin venturi (2) creating a vacuum by evacuating air from the pump body and suction hose (3), while the non-return valve ball (4) seals out air from the discharge, allowing fluid to enter the pump body (5) and begin pumping automatically.

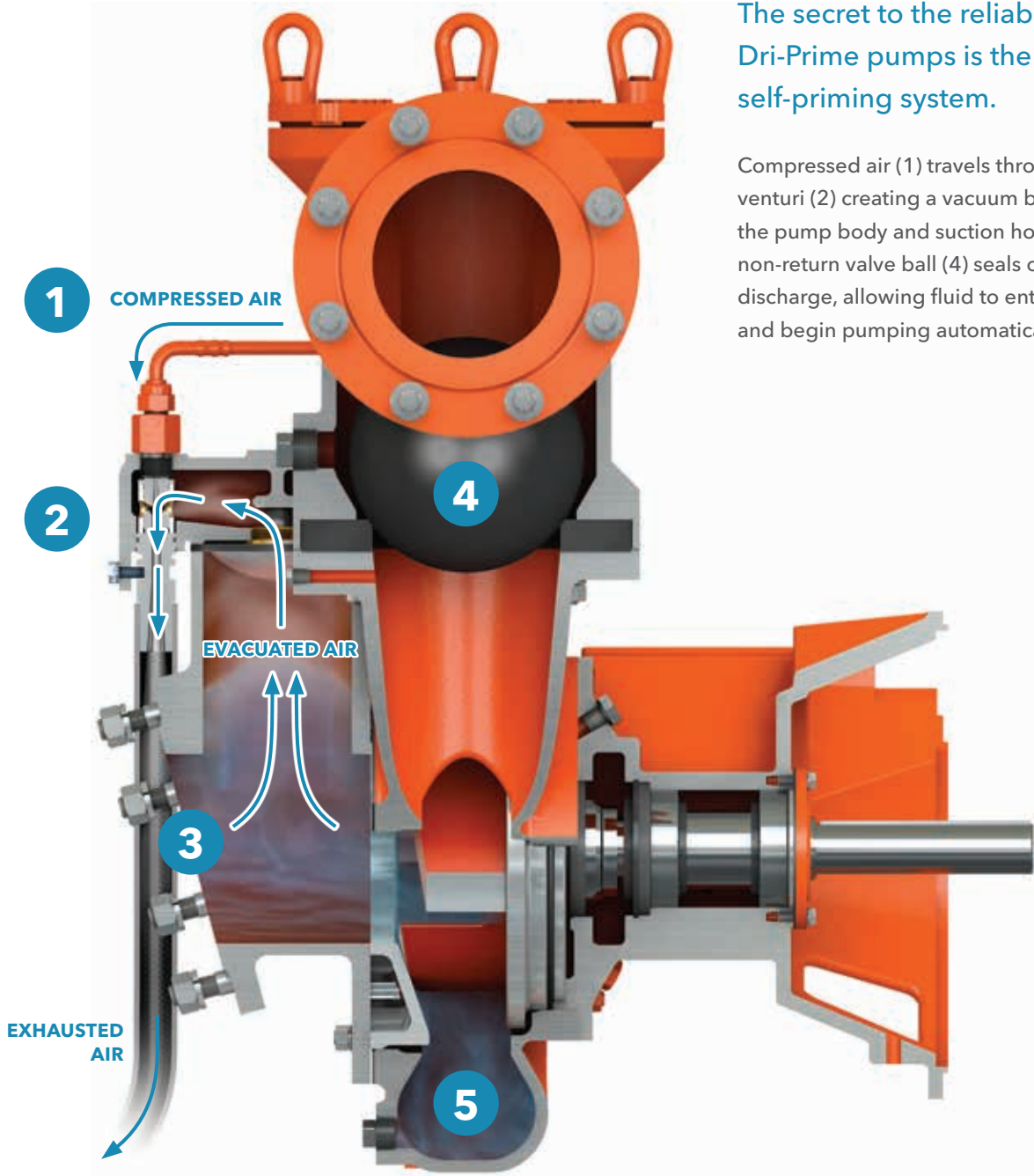

Quiet and Protected

The Critically Silenced unit houses Dri-Prime, Heidra, Wellpoint, and Rotary Lobe pumps in a specially designed, acoustically-silenced enclosure.

The Critically Silenced enclosure is ideal for use in any application where pumping is required and engine and other noise must be kept to a minimum. Sound levels are approximately 69 dBA at 30 feet. The Critically Silenced unit is engineered from start to finish for quiet operation. The enclosure consists of 14 gauge sheet metal (12 gauge for larger units) lined with one- and two-inch layers of polydamp acoustical sound-deadening material.

We have designed the engine with a critical grade silenced muffler, silenced the priming exhaust, and isolated engine vibration to further reduce operating noise. Hinged, lockable doors provide convenient access to operating controls and service locations. For added versatility, the entire skid mounted unit can be unbolted and removed from the DOT highway trailer.



Dri-Prime: The Features That Set The Standard

Godwin Dri-Prime pumps transport raw sewage, sludges and fluids with solids up to 5 inches in diameter. The pumps prime automatically from dry to 28 feet of suction lift, and can run dry.



DIESEL POWERED

Equipped with a diesel engine for stand-alone operation, these pumps will work on any site, no matter how remote. All engines meet the latest emissions regulations including Tier 4.



ELECTRIC POWERED

All CD, HL and NC series Dri-Prime pumps are available with electric motors, for both temporary and permanent installation. Electric-powered pumps do not need refueling, the motor requires less servicing, and they reduce the carbon footprint of any project.



REDUCED LABOR COSTS AND RELIABLE OPERATION

The Dri-Prime offers automatic priming from dry to 28 feet, without a need for operator assistance or foot valve control. With no moving mechanical parts in the priming device, Godwin Dri-Prime CD, HL and NC series pumps will prime and re-prime from dry day after day.

DRY-RUNNING AND REDUCED MAINTENANCE COSTS

Seals in pumps that often run dry can overheat and fail. Godwin mechanical shaft seals run a liquid bath, which dissipates heat through the pump casing and allows the pump to run dry indefinitely. This provides more reliable operation, frees operators from closely monitoring the pumps, and reduces maintenance costs.

TROUBLE-FREE PERFORMANCE

Godwin standard mechanical seals feature silicon carbide faces. They are highly resistant to abrasion and provide a long, trouble-free service life.

VERSATILITY AND FEWER STOPPAGES

With their open impeller design, Godwin Dri-Prime pumps handle solids up to 5 inches in diameter, reducing the risk of clogging or stoppage. The open impeller design also means Godwin pumps can be used in a wide range of applications from water and wastewater, to drilling muds and industrial fluids.

DURABLE PUMP-END FOR A LONG LIFETIME

Cast iron, our standard build, offers excellent durability. But different applications require greater resistance to abrasion, erosion and corrosion. That's why we offer a variety of other metals such as stainless steel, cast steel, hard iron and high chrome.



SUPERIOR RESISTANCE

The pump-end is available with wetted parts in 316 or CD4MCu stainless steel for pumping liquids with pH values between 2 and 12. For pumping abrasive liquids, hardened wear plates are also available.

EASY ONSITE INSTALLATION

With a single lifting point and forklift pockets, it is easy to move Dri-Prime pumps around sites with standard construction equipment. Pumps weighing more than 12 tons are equipped with four lifting points. Simple to install, regardless of the environment, you can have your pumps up and running quickly.

REDUCED LABOR COSTS

Diesel driven Dri-Prime pumps can run overnight without the need to refuel – a real saving in labor costs.

SKID- OR TRAILER-MOUNTED FOR HIGH MOBILITY

The skid-mounted pumps are designed for convenient handling with a forklift, while the trailer-mounted pumps are built for road and highway transportation using standard vehicles.



FLEXIBILITY OF USE AND ENERGY SAVINGS

The pumps can operate at various duty points, enabling you to use the same pump for different tasks. By matching the engine or motor speed to each job, the result is substantial fuel/energy savings.

AUTOMATIC OPERATION

The intelligent control panel enables automatic operation, which minimizes the need for manual monitoring. This, together with level control floats, provides increased fuel efficiency, reduced operating costs, plus greater peace of mind.

EASY TO SERVICE PUMP-END

The close-coupled design of the pump makes alignments unnecessary, which means that you benefit from simple pump-end changeover in the field.

LONGER SEAL AND BEARING LIFETIME

The close-coupling of the impeller and engine/motor reduces shaft deflection at the seals. This results in lower vibration, quieter operation, and a longer seal and bearing life.

ENVIRONMENTAL PROTECTION

Fuel tanks for pumps fitted with quiet enclosures are double-walled for environmental protection. Open set pumps feature a bunded fuel tank to catch any spillage associated with fueling the diesel engine. This makes Godwin Dri-Prime pumps safe and easy to transport and store.

Godwin Diesel Dri-Prime CD Series







High Volume, Medium-Head, Large Solids-Handling Capabilities

- Flow: 0 - 16,500 gpm
- Head: 95 - 280 ft

OPTIONS INCLUDE

- 316 or CD4MCu stainless steel pump-end construction for high and low pH applications
- Highway trailer or skid mount, both incorporating integral overnight running fuel tanks
- Sound attenuated enclosures







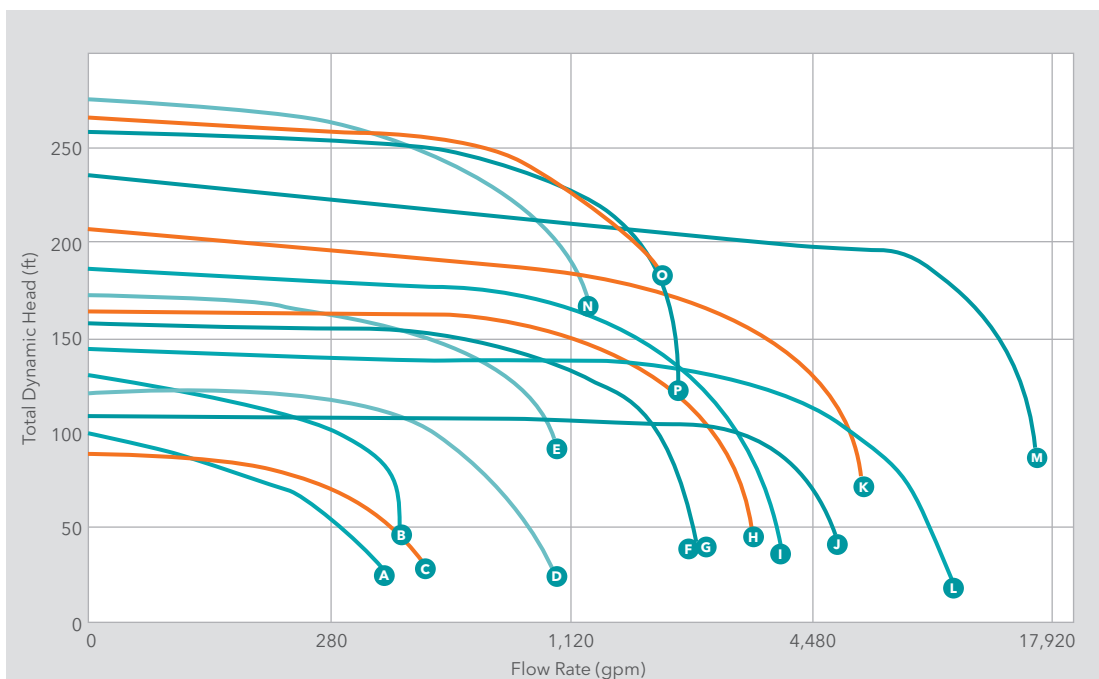

	CD75MA5	CD80D	CD80M	CD100M	CD103M	CD150M	CD200M
							
Branch Size (in)	2x2/3x3	3x3	3x3	4x4	4x4	6x6	8x8
Flow Range (gpm)	0-300	0-350	0-350	100-750	300-1,000	700-2,080	800-2,300
Max Total Dynamic Head (ft)	105	135	95	125	175	160	160
HP@RPM	17@3,000	20@3,000	18@2,200	30@2,200	46@2,200	74@2,200	74@2,200
Solids Handling (in)	1 5/8	1 5/8	1 5/8	1 3/4	3	3	3
Impeller Diameter (in)	6 3/4	6 5/8	7 1/2	9 1/8	10 1/8	11	11
Standard Mount	Trailer	Trailer	Trailer	Trailer	Trailer	Trailer	Trailer
Height (in)	70	70	70	70	77	77	77
Length (in)	102	102	102	102	119	119	119
Width (in)	54	54	54	54	66	66	66
Wet Weight (lb)	1,770	1,770	1,800	2,100	2,830	3,630	3,690
Performance Curve	A	B	C	D	E	F	G

Performance curves

- A** CD75MA5
- B** CD80D
- C** CD80M
- D** CD100M
- E** CD103M
- F** CD150M
- G** CD200M
- H** CD225M
- I** CD250M
- J** DPC300
- K** CD300M
- L** CD400M
- M** CD500M
- N** CD140M
- O** CD160M
- P** CD180M

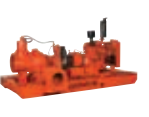

Composite curves for comparison purposes only. Consult engineering data for exact flow and head capabilities.

						Elevated Head, Solids Handling		
CD225M	CD250M	DPC300	CD300M	CD400M	CD500M	CD140M	CD160M	CD180M
								
8x8	10x10	12x12	12x12	18x18	24x18	4x4	6x6	8x6
1,000-3,100	1,500-3,600	2,000-5,000	3,000-6,000	4,000-10,000	8,000-16,500	300-1,000	700-1,700	1,000-2,090
170	185	115	205	145	240	280	265	260
99@2,200	156@2,200	156@2,400	300@1,800	300@1,800	700@1,800	119@2,000	149@2,000	149@2,000
3	3	3 ¾	3 ¾	4 ⅞	3 ⅞	3	3	3
11 ⅞	11 ⅞	16 ⅞	14 ¼	19 ⅞	24	13 ⅞	14	14
Trailer	Skid Base	Skid Base	Skid Base	Skid Base	Skid Base	Skid Base	Skid Base	Skid Base
93	102	81	97	100	97	77	84	84
155	168	156	160	183	204	121	147	147
76	76	55	71	86	101	53	56	56
5,600	6,790	7,330	11,230	15,580	22,640	5,700	6,910	6,910
H	I	J	K	L	M	N	O	P

Godwin Diesel Dri-Prime HL Series

High-Head and Jetting Pumps with Solids-Handling Capabilities

- Flow: 0 - 5,300 gpm
- Head: 320 - 630 ft

OPTIONS INCLUDE

- 316 or CD4Mcu stainless steel pump-end construction for high and low pH applications
- Highway trailer or skid mount, for overnight running with fuel tanks
- Sound attenuated enclosures



	HL80M	HL100M	HL125M	HL150M	HL200M
					
Branch Size (in)	4x3	4x4	6x4	6x6	8x6
Flow Range (gpm)	0-450	300-800	300-1,000	500-1,450	800-2,300
Max Total Dynamic Head (ft)	330	380	450	505	320
HP@RPM	74@2400	99@2200	156@2400	225@2400	225@2000
Solids Handling (in)	1	1 ½	1 ½	1 ½	1 ½
Impeller Diameter (in)	12 13/16	14 3/8	14 3/8	15 3/8	15 3/8
Standard Mount	Trailer	Trailer	Skid Base	Skid Base	Skid Base
Height (in)	77	93	84	87	84
Length (in)	119	155	147	147	147
Width (in)	66	76	53	55	55
Wet Weight (lb)	3,380	5,070	6,410	7,450	7,620
Performance Curve	A	B	C	D	E

Performance curves

- A HL80M
- B HL100M
- C HL125M
- D HL150M
- E HL200M
- F HL225M
- G HL250M
- H HL110M
- I HL130M
- J HL160M
- K HL260M

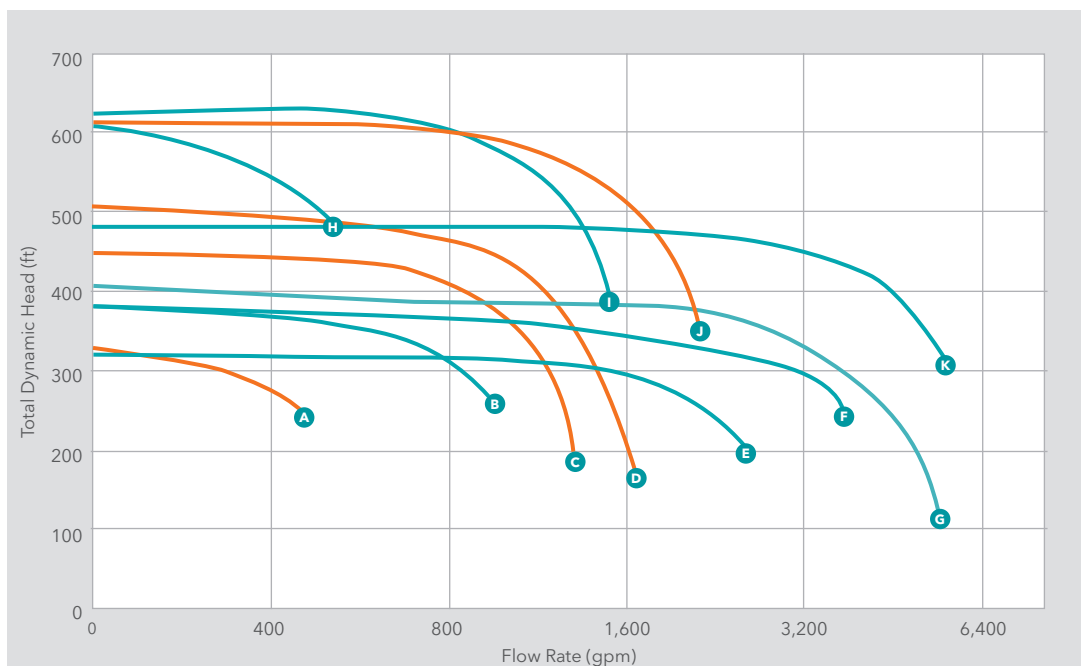

Composite curves for comparison purposes only. Consult engineering data for exact flow and head capabilities.

Extreme High-Head

HL225M	HL250M	HL110M	HL130M	HL160M	HL260M
					
10x8	12x10	4x3	6x4	8x6	10x10
1,500-3,600	2,500-5,200	200-600	400-1,300	400-2,000	1,500-5,300
380	405	615	630	620	480
300@2000	475@2000	156@2200	300@2100	475@2000	700@1800
2 ½	2 ½	¾	¾	1 ¾	2
17 ⅝	17 ⅝	18 ⅝	20 ¼	20	21 ¼
Skid Base	Skid Base	Skid Base	Skid Base	Skid Base	Skid Base
97	95	84	97	95	99
152	162	147	152	162	168
62	70	53	60	67	79
10,560	14,030	6,740	10,490	14,040	17,550
F	G	H	I	J	K

Godwin NC Series Pumps Featuring Flygt N-technology

Stringy Material Applications

Godwin NC Series Dri-Prime pumps are extremely powerful yet compact pumps designed to handle fibrous stringy material and general dewatering applications. Godwin NC pumps deliver the highest total system efficiency, lowering fuel bills and reducing unplanned maintenance costs. They also feature Flygt N-technology with an innovative self-cleaning impeller.

- Flow: 0 - 6,000 gpm
- Head: 115 - 205 ft

Performance curves

- A** NC80
- B** NC100
- C** NC150
- D** NC350

Composite curves for comparison purposes only. Consult engineering data for exact flow and head capabilities.

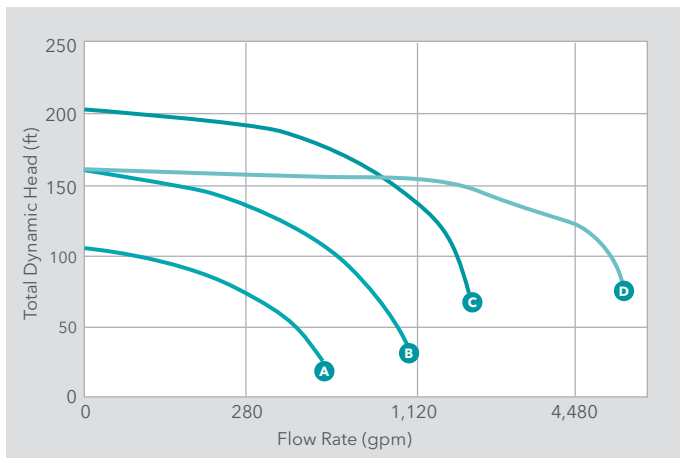

	NC80	NC100	NC150	NC350
				
Branch Size (in)	4x3	4x4	6x6	16x16
Flow Range (gpm)	0-350	100-750	700-1,700	3,000-6,000
Max Total Dynamic Head (ft)	110	165	205	160
HP@RPM	15@2200	30@2200	75@2200	300@1800
Impeller Diameter (in)	8 7/8	10 1/8	11 1/4	18 1/8
Standard Mount	Trailer	Trailer	Trailer	Skid Base
Height (in)	70	77	77	99
Length (in)	102	119	119	185
Width (in)	54	66	66	83
Wet Weight (lb)	1,940	2,660	3,500	16,020
Performance Curve	A	B	C	D

Godwin Electric Drive Dri-Prime

Designed for long lasting durability, the electric drive Dri-Prime pump is ideally suited for both temporary pumping and permanent installations where electricity is available.

Perfect for industrial and municipal applications, a permanently installed electric drive Dri-Prime pump provides reliable, continuous pumping and reduced operating and maintenance costs. An electric drive Dri-Prime is also a great solution for temporary jobs where refueling is difficult.

Electric drive Dri-Prime pumps can be customized by adding an optional variable-frequency drive (VFD). Chemical resistant and explosion proof options are available upon request.

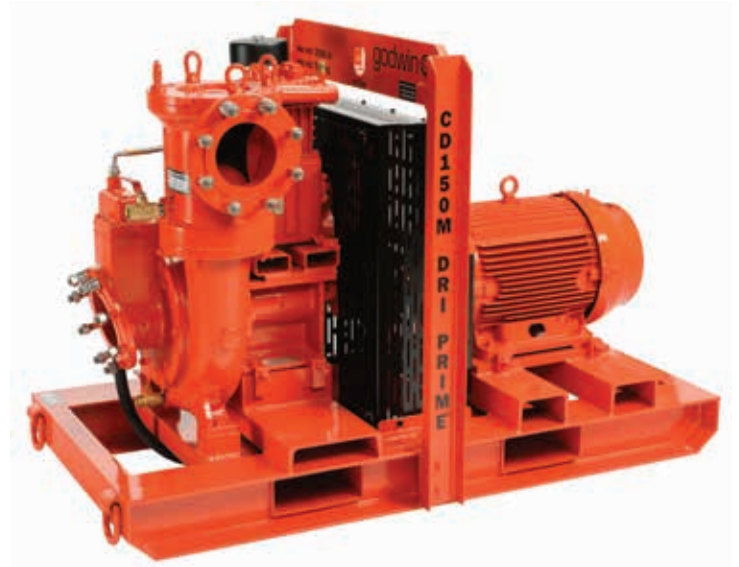

Godwin Electric Dri-Prime CD Series

High Volume, Medium-Head and Large Solids-Handling Capabilities

- Handle raw sewage, sludges and liquids with solids up to 5 inches
- Automatic priming from dry to 28 feet
- Electric motor for long lasting durability where refueling is impractical
- Cast steel impeller

OPTIONS INCLUDE

- 316 or CD4MCu stainless steel pump-end construction for high and low pH applications
- Highway trailer or skid mount



	CD75MA5	CD80D	CD80M	CD100M	CD103M	CD150M	CD200M
Branch Size (in)	2x2/3x3	3x3	3x3	4x4	4x4	6x6	8x8
Flow Range (gpm)	0-300	0-350	0-350	100-750	300-1,000	700-2,080	800-2,300
Max Total Dynamic Head (ft)	74	71	93	115	170	167	170
HP@RPM	10@1,800	10@1800	10@1800	20@1,800	30@1,800	50@1,800	50@1,800
Voltage/Phase	230/460	230/460	230/460	230/460	230/460	230/460	230/460
Amps	26/13	26/13	26/13	50/25	72/36	120/60	120/60
Solids Handling (in)	1 5/8	1 5/8	1 5/8	1 3/4	3	3	3
Impeller Diameter (in)	6 3/4	6 5/8	7 1/2	9 1/8	10 1/8	11	11
Standard Mount	Skid Base	Skid Base	Skid Base	Skid Base	Skid Base	Skid Base	Skid Base
Height (in)	42	42	42	43	47	47	51
Length (in)	27	54	54	60	70	68	70
Width (in)	54	27	27	30	32	31	30
Wet Weight (lb)	850	875	1,000	1,250	1,600	2,050	2,040
Performance Curve	A	B	C	D	E	F	G

Performance curves

- A CD75MA5
- B CD80D
- C CD80M
- D CD100M
- E CD103M
- F CD150M
- G CD200M
- H CD225M
- I CD250M
- J DPC300
- K CD300M
- L CD400M
- M CD500M
- N CD140M
- O CD160M
- P CD180M

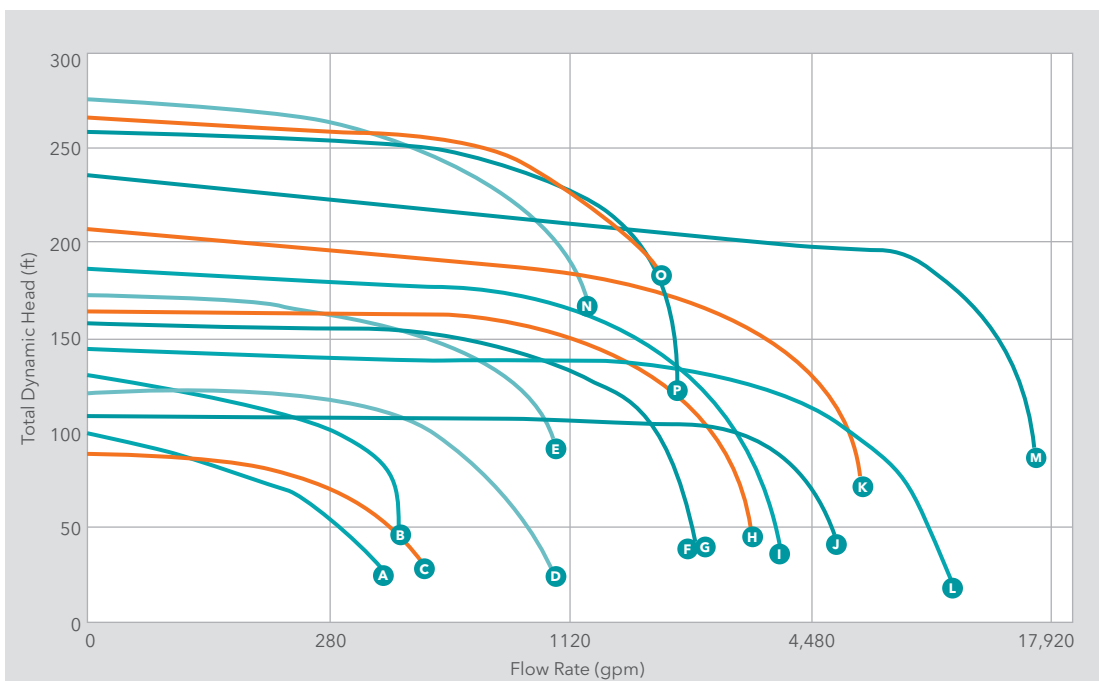

Composite curves for comparison purposes only. Consult engineering data for exact flow and head capabilities. Curves based on pumps maximum speed shown performance. May require use of VFD's for max performance.

						Elevated Head, Solids Handling		
CD225M	CD250M	DPC300	CD300M	CD400M	CD500M	CD140M	CD160M	CD180M
8x8	10x10	12x12	12x12	18x18	24x18	4x4	6x6	8x6
1,000-3,100	1,500-3,600	2,000-5,000	3,000-6,000	4,000-10,000	8,000-16,500	300-1,000	700-1,700	1,000-2,090
180	183	115	200	147	200	280	255	260
75@1,800	100@1,800	125@1,200	200@1,800	250@1,200	800@1,200	75@1,800	150@1,800	150@1,800
230/460	460	460	460	460	4160	230/460	460	460
184/92	115	145	232	300	99	184/92	170	170
3	3	3 ¾	3 ¾	4 ⅞	3 ½	3	3	3
11 ⅞	11 ⅞	16 15/16	14 ¼	19 11/16	24	13 5/16	14	14
Skid Base	Skid Base	Skid Base	Skid Base	Skid Base	Skid Base	Skid Base	Skid Base	Skid Base
55	55	56	54	70	66	57	50	72
80	84	108	120	140	204	80	92	98
46	54	57	63	87	101	42	48	49
3,416	4,000	5,400	7,450	12,000	25,880	2,380	5,120	5,120
H	I	J	K	L	M	N	O	P

Godwin Electric Dri-Prime HL Series

High-Head and Jetting Pumps with Solids-Handling Capabilities

Godwin HL series Dri-Prime pumps offer higher discharge head capabilities, to 600 feet or 260 psi with single stage impeller design. The pumps will handle raw sewage, sludges and liquids with solids up to 3 inches in diameter, and offer automatic priming to 28 feet.

Like CD series Dri-Prime pumps, HL series pumps are available with:

- Electric motor for long lasting durability where refueling is difficult
- Dry-running liquid bath seal arrangements with abrasion resistant silicon carbide interfaces
- Cast steel impeller for longer life
- 316 or CD4Mcu stainless steel pump-end construction for high and low pH applications
- Highway trailer or skid mount

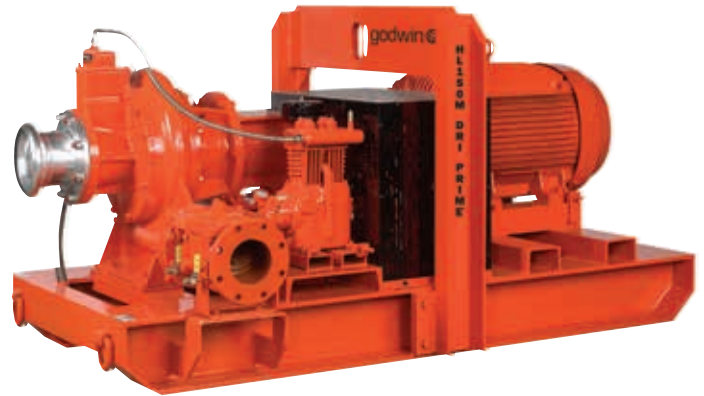

	HL80M	HL100M	HL125M	HL150M	HL200M
Branch Size (in)	4x3	4x4	6x4	6x6	8x6
Flow Range (gpm)	0-450	300-800	300-1,000	500-1,450	800-2,300
Max Total Dynamic Head (ft)	325	455	455	500	320
HP@RPM	50@1,800	75@1,800	75@1,800	125@1,800	150@1,800
Voltage/Phase	230/460	230/460	230/460	460	460
Amps	120/60	184/92	184/92	145	170
Solids Handling (in)	1	1 3/8	1 3/8	1 3/8	1 1/2
Impeller Diameter (in)	12 13/16	14 3/16	14 3/16	15 3/16	15 3/4
Standard Mount	Skid Base	Skid Base	Skid Base	Skid Base	Skid Base
Height (in)	47	58	64	61	50
Length (in)	68	80	78	84	100
Width (in)	40	40	41	47	53
Wet Weight (lb)	2,050	3,000	3,100	4,056	5,375
Performance Curve	A	B	C	D	E

Performance curves

- A HL80M
- B HL100M
- C HL125M
- D HL150M
- E HL200M
- F HL225M
- G HL250M
- H HL110M
- I HL130M
- J HL160M
- K HL260M

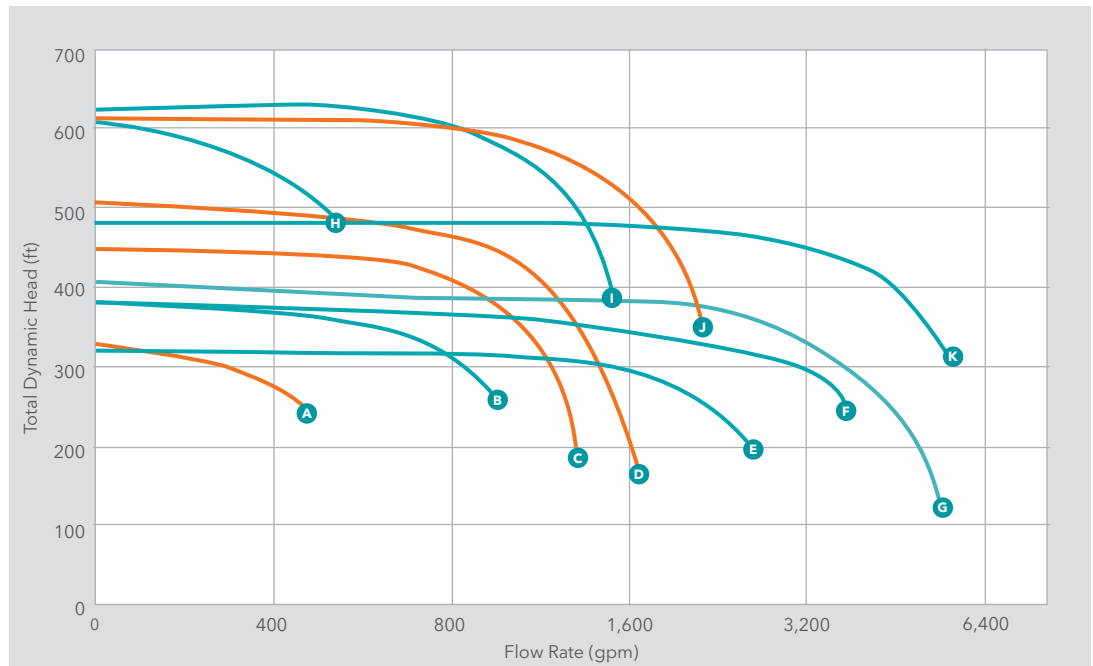

Composite curves for comparison purposes only. Consult engineering data for exact flow and head capabilities. Curves based on pumps maximum speed shown performance. May require use of VFD's for max performance.

		Extreme High-Head			
HL225M	HL250M	HL110M	HL130M	HL160M	HL260M
10x8	12x10	4x3	6x4	8x6	10x10
1,500-3,600	2,500-5,200	200-600	400-1,300	400-2,000	1,500-5,300
380	380	600	640	600	500
300@1,800	400@1,800	200@1,800	300@1,800	400@1,800	600@1,800
460	460	460	460	460	460/4160
360	445	232	360	445	720/75
2½	2½	¾	¾	1¾	2
17 ⅝	17 ⅝	18 ⅝	20 ¼	20	21 ¼
Skid Base	Skid Base	Skid Base	Skid Base	Skid Base	Skid Base
65	63	50	54	63	73
114	144	86	114	126	156
62	72	49	61	66	71
9,272	10,190	6,083	7,450	10,150	14,591
F	G	H	I	J	K

Godwin NC Series Pumps Featuring Flygt N-technology

Stringy Material Applications

Godwin NC Series Dri-Prime pumps are extremely powerful yet compact pumps designed to handle the toughest stringy material and general dewatering applications. Godwin NC pumps deliver the highest total system efficiency, lowering fuel bills and reducing unplanned maintenance costs. They also feature Flygt N-technology with an innovative self-cleaning impeller.

- Flow: 0 - 6,000 gpm
- Head: 109 - 206 ft

Performance curves

- A** NC80
- B** NC100
- C** NC150
- D** NC350

Composite curves for comparison purposes only. Consult engineering data for exact flow and head capabilities.

Curves based on pumps maximum speed shown performance. May require use of VFD's for max performance.

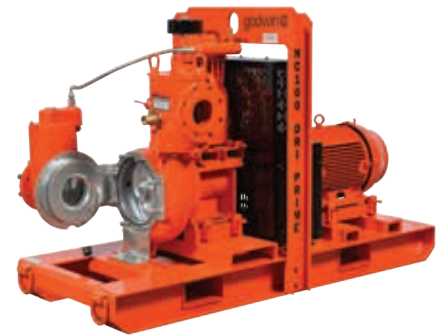
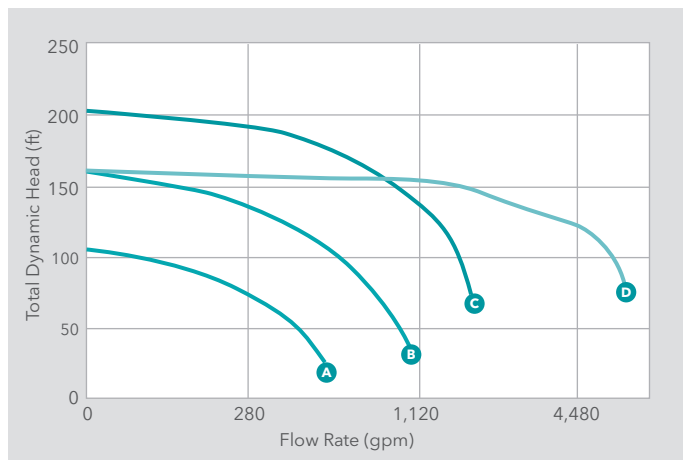

	NC80	NC100	NC150	NC350
Branch Size (in)	4x3	4x4	6x6	16x16
Flow Range (gpm)	0-350	100-750	700-1,700	3,000-6,000
Max Total Dynamic Head (ft)	109	165	206	160
HP@RPM	10@1,800	20@1,800	50@1,800	250@1,200
Voltage/Phase	230/460	230/460	230/460	460
Amps	26/13	50/25	120/60	300
Impeller Diameter (in)	8 5/16	10 1/16	11 1/4	18 1 1/16
Standard Mount	Skid Base	Skid Base	Skid Base	Skid Base
Height (in)	43	45	47	70
Length (in)	54	68	68	140
Width (in)	24	31	31	87
Wet Weight (lb)	1,000	1,600	2,050	12,000
Performance Curve	A	B	C	D



Dri-Prime Backup System

The Godwin Dri-Prime Backup System (DBS™) offers peace-of-mind with a reliable lift station contingency plan. With the DBS, you'll have backup pumping instead of backup power.

The Dri-Prime Backup System is engaged during loss of primary power or switch gear failure. It can also be used during routine pump maintenance or unexpected pump failure. The DBS is available with Optional Flygt N-technology, for sustained efficiency while handling stringy material.

DBS Features and Benefits

- 100% pump station redundancy
- PrimeGuard 2 digital control panel allows seamless interface to existing control systems
- Field Smart Technology (FST) provides remote monitoring and control
- The Godwin DBS is available in 3" to 24" sizes with flows to 15,000 gpm and discharge heads to 600 feet

Options

- Flexible fuel options to meet your needs:
diesel, natural gas, or LP vapor
- Flygt N-technology
- Cold weather package for use in freezing conditions

Godwin Heidra® Submersible Pumps









The Godwin Heidra series features hydraulic-drive pump-ends, which include rugged cast steel impellers for general pumping of slurries and sludges.

- Available semi-recessed vortex impeller for sewage and solids handling up to 5 inches
- Pump bearings independent of hydraulic motor, which means that loads will not affect motor reliability
- Double mechanical seal design, carbon upper surfaces and silicon carbide lower surfaces



	Heidra 80	Heidra 100TD	Heidra 100SG	Heidra 100NC	Heidra 103	Heidra 150MR	Heidra 150V	Heidra 150SG
								
Branch Size (in)	3" FNPT	4" FNPT	4" ASA 150	4" FNPT	4" FNPT	6" FNPT	6" FNPT	6" ASA 150
Flow Range (gpm)	0-350	100-750	100-750	100-750	300-1,000	700-1,900	700-1,900	700-1,900
Max Total Dynamic Head (ft)	85	115	115	135	170	170	75	170
Solids Handling (in)	1½	2	2	–	3	3	5	3
Impeller Diameter (in)	7½	9½	9½	10	10	11	11	11
Pump-end Hydraulic Motor	Gear type	Gear type	Gear type	Gear type	Gear type	Gear type	Gear type	Gear type
Drive Pressures (psi)	2,800	3,500	3,500	3,500	2,500	3,500	3,500	3,500
Height (in)	20	23	33	21	25	27	32	34
Length (in)	14	19	29	16	20	20	20	19
Width (in)	14	19	17	32	20	23	23	32
Weight (lbs)	100	141	255	374	325	355	403	370
* Power Pack	GHPU10 (Heidra 80)	GHPU10	GHPU10SG	GHPU30	GHPU30 (Heidra 103)	GHPU30	GHPU30	GHPU30SG

* POWER PACKS	GHPU10 (Heidra 80)	GHPU10	GHPU10SG	GHPU30 (Heidra 103)	GHPU30	GHPU30SG	GHPU50/ GHPU50SG	GHPU90
HP@RPM	18@2,600	34@2,600	34@2,600	41@2,200	71@2,400	71@2,400	147@2,200	225@2,100
Hydraulic Reservoir Capacity (gal)	10	10	10	40	40	40	75	75
Hydraulic Oil Flow Rate (gpm)	4-9	4-9	4-9	17-35	17-35	18-36	30-55	50-90
Powerpack Hydraulic Pump	Gear type	Gear type	Gear type	Gear type	Gear type	Piston type	Piston type	Piston type
Drive Pressures (psi)	2,500	3,500	3,500	2,500	3,500	3,500	4,000	4,000
Standard Mount	Trailer	Trailer	Trailer	Trailer	Trailer	Trailer	Skid Base	Skid Base
Height (in)	71	71	73	73	78	133	72	72
Length (in)	96	96	109	109	119	70	138	135
Width (in)	55	40	65	65	66	72.5	53	53
Weight (lbs)	1,230	1,450	2,400	2,400	2,996	3,000	6,500	8,900

						High-Head		
Heidra 150VSG	Heidra 150NC	Heidra 200	Heidra 200SG	Heidra 250	Heidra 300	Heidra 80HH	Heidra 110HH	Heidra 150HH
								
6" ASA 150	6" FNPT	8" ASA 150	8" ASA 150	10" ASA 150	12" ASA 150	3" ASA 150	3" ASA 300	6" ASA 150
700-1,900	700-1,700	1,000-3,100	1,000-3,100	1,500-3,600	3,000-6,000	0-450	200-600	500-1,450
75	180	180	180	185	205	325	600	500
3	-	3 ¼	3	3 ¼	3 ¾	1	¾	1 ⅜
11	11	11 ⅞	11 ⅞	11 ⅞	14 ¼	12 ⅜	18 ⅞	15 ⅞
Gear type	Gear type	Piston type	Piston type	Piston type	Piston type	Gear type	Piston type	Piston type
3,500	3,500	4,000	4,000	4,000	5,000	3,500	4,000	4,000
37	32	49	51	49	72	20	50	50
17	23	23	28	28	55	20	26	26
32	18	23	40	28	41	18	24	24
429	386	777	931	800	2080	374	800	800
GHPU30SG	GHPU30	GHPU50	GHPU50SG	GHPU50	GHPU90	GHPU30	GHPU90	GHPU50/ GHPU90

Godwin Sub-Prime® Submersible Pumps

Electric Submersible Pumps

All of these pumps have durable silicon carbide upper and lower seals to run dry without damage.

Small Dewatering Pumps

- Compact, lightweight, slim-line, top discharge design to fit into confined spaces
- Reliable high-torque, capacitor-start motor with thermal overload protection and non-wicking cable

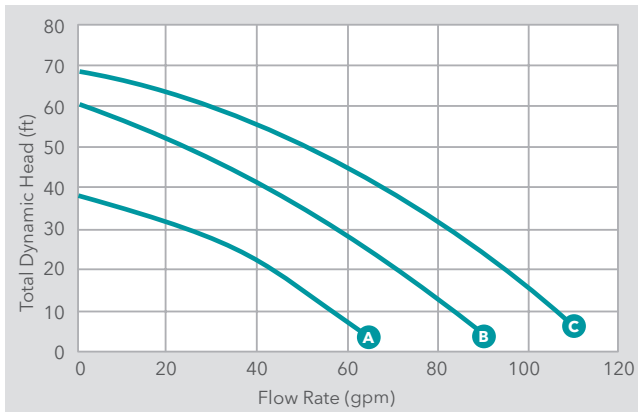

- A GSP05
 - B GSP10
 - C GSP20
- 
 C N/A for GSP20



Small Trash Pumps

- Side discharge, semi-vortex impeller and fully removable abrasion-resistant volute
- Handles up to 1 inch spherical solids
- Reliable high-torque, capacitor-start motor with thermal overload protection and non-wicking cable

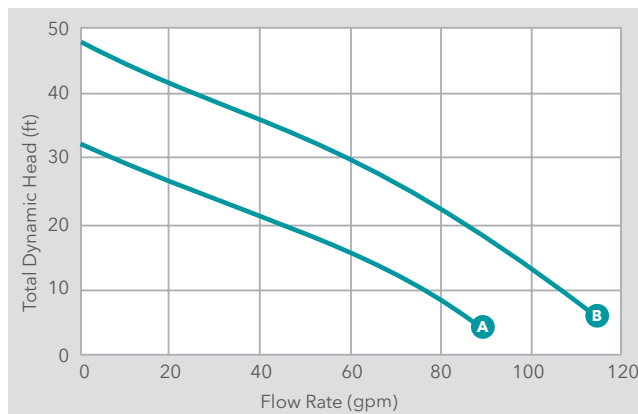

- A GST05
 - B GST10
- 
 C



SlimLine Dewatering Pumps

- Available in Single phase 115/230V and Three phase 230/460V models
- Compact, lightweight, slim-line, top discharge design to fit into confined spaces
- Cast steel impeller and heavy-duty rubber coated adjustable wearparts for maximum pump life

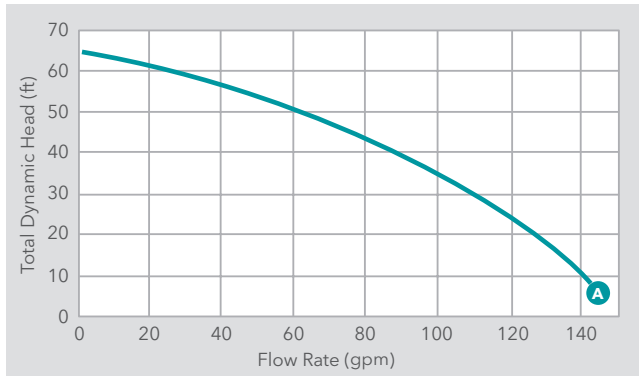

A GSP20SL

 C US



	Rated HP	Speed RPM	Operating Voltage	Rated Current Amps	Discharge Connection (in)	Weight (lbs)	Maximum Height (in)	Maximum Width (in)	Maximum Solids (in)
--	----------	-----------	-------------------	--------------------	---------------------------	--------------	---------------------	--------------------	---------------------

GSP SMALL DEWATERING PUMPS

GSP05 (1Ø)	0.5	3,600	115/230	5.8/3.2	2	20	12 ½	7 ½	½
GSP10 (1Ø)	1.0	3,600	115/230	10.3/5.11	2	29	14 ½	7 ½	½
GSP20 (1Ø)	2.0	3,600	115/230	25.9/13.0	3	61	24 ½	9 ¼	½

GST SMALL TRASH PUMPS

GST05 (1Ø)	0.5	3,600	115/230	5.8/2.9	2	22	14 ¾	9 ¾	1
GST10 (1Ø)	1.0	3,600	115/230	10.3/5.1	2	29	16 ¾	9 ¾	1

GSP-SL SLIMLINE DEWATERING PUMPS

GSP20SL (1Ø)	2.0	3,600	115/230	22/11	3 Std./2 Opt.	65	26 ¾	7 ¾	½
GSP20SL (3Ø)	2.0	3,600	230/460, 575	6/3, 2.5	3 Std./2 Opt.	65	21 ½	7 ¾	½

Godwin Wellpoint Pumps

Construction Dewatering Systems

Godwin wellpoint pumps include a centrifugal, single stage end suction pump with high volume, belt driven vacuum pump and single action float air/water separation tank. Features include hardened wearparts and a dry-running liquid bath mechanical seal.

Self-jetting Godwin wellpoint pumps and header pipe create a system that is easy to transport and set up. With up to 20° deflection at header coupling joints, the pipes adapt easily to site and ground conditions without loss of suction or pressure integrity.



- Flow: 100 - 3,100 gpm
- Head: 77 - 220 ft
- Solids Handling: Up to 3 1/8 inches in diameter
- Air Handling Capabilities: Up to 200 cfm

	CD100MV	CD150MV	CD225MV
Branch Size (in)	4x4	6x6	8x8
Flow Range (gpm)	100-750	700-1,700	1,000-3,100
Max Total Dynamic Head (ft)	77	110	220
HP@RPM	17@1,800	60@1,800	75@1,800
Voltage/Phase	230/460	230/460	230/460
Amps	50/25	120/60	184/92
Solids Handling (in)	1 3/4	3	3 1/2
Impeller Diameter (in)	9	11	11 3/8
Standard Mount	Trailer	Trailer	Skid Base
Height (in)	43	73	78
Length (in)	60	129	120
Width (in)	30	70	53
Wet Weight (lb)	1,250	4,500	6,000
Performance Curve	A	B	C

Performance curves

- A** CD100MV
- B** CD150MV
- C** CD225MV

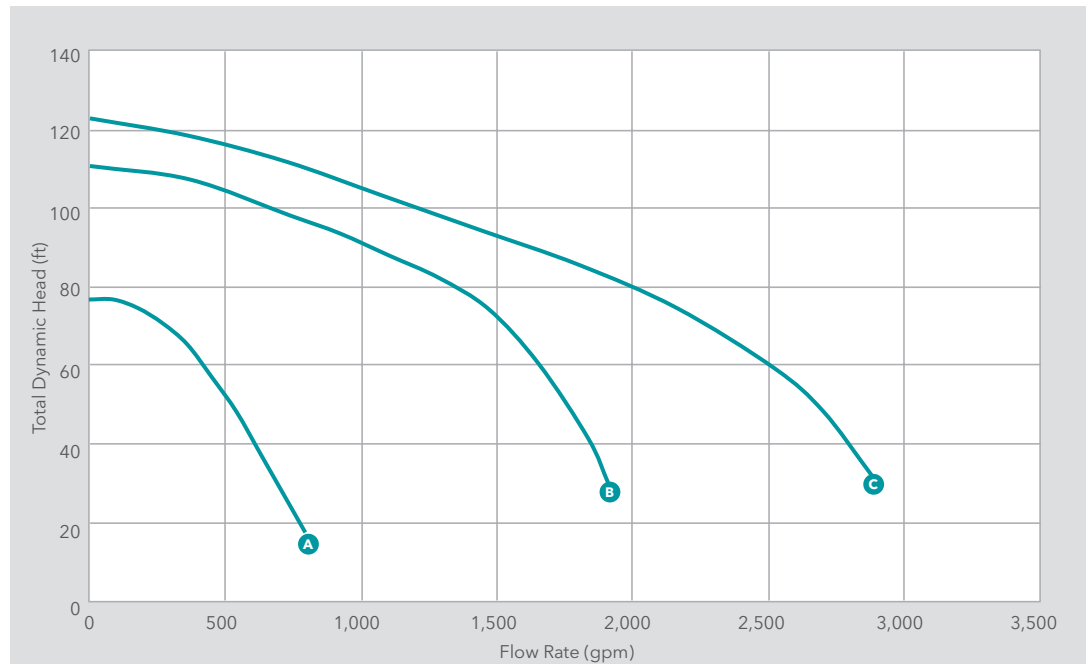

Composite curves for comparison purposes only. Consult engineering data for exact flow and head capabilities.

Quick Disconnect Wellpoint Dewatering Pipes

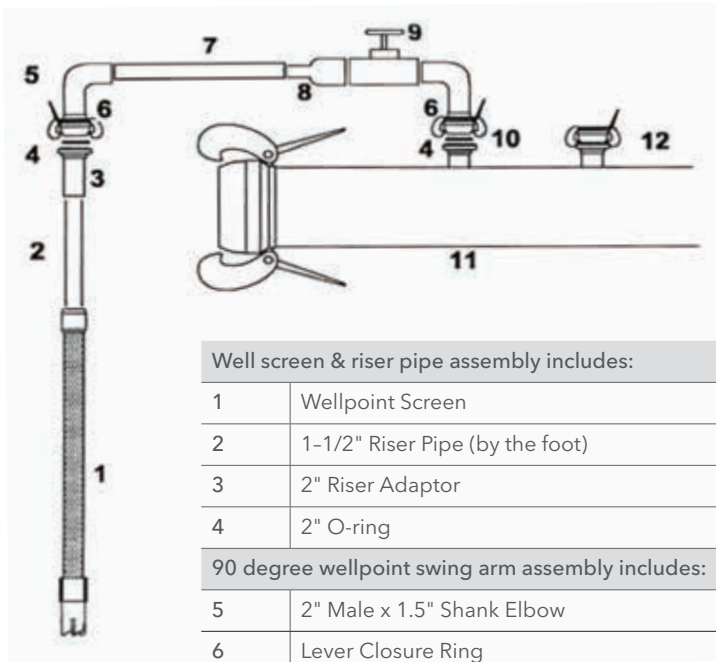

Well screen & riser pipe assembly includes:	
1	Wellpoint Screen
2	1-1/2" Riser Pipe (by the foot)
3	2" Riser Adaptor
4	2" O-ring
90 degree wellpoint swing arm assembly includes:	
5	2" Male x 1.5" Shank Elbow
6	Lever Closure Ring
7	1-1/2" Clear Suction Hose (per foot)
8	1-1/2" Hose Shank x Male NPT
9	1-1/2" Gate Valve
10	2" Male x 1.5" Male NPT Elbow
Accessories:	
11	QD Header Pipe
12	2" MQD Dust Plug W/Lever

Godwin Rotary Lobe Pumps

Godwin rotary lobe pumps service a range of on-site dewatering applications, including wellpointing and sock dewatering. The positive displacement-style rotary lobe pumps are available in 6, 8 and 12 inch models. These pumps offer the best longevity and performance in minimally abrasive pumping environments.

- Capable of achieving higher flow rates with less horsepower, thereby reducing fuel and overall operational costs
- Removable front cover for inline maintenance access without disturbing piping connections
- Reduced vibration from rotational speed, increasing operating speed capabilities and decreasing vibrational wear on downstream equipment
- Formed steel pump casing for extended wear
- Available with diesel or electric drive
- Max Capacity: 325 - 3,175 gpm
- Suction Lift: 29 ft
- Max Air Handling: 45 - 425 cfm



	GRL150	GRL200	GRL300
Pipe Connections	6x6	8x8	12x12
Max Capacity (gpm)	325	1,560	3,175
Displacement/Revolution (gal)	0.65	2.6	2.6
Max Working Pressure	30 psi	30 psi	30 psi
Max Normal Op. Speed - Pump (rpm)	500	500	500
Max Normal Op. Speed - Engine (rpm)	1875	2,000	1,500
Suction Lift (ft)	29	29	29
Max Air Handling (cfm)	45	208	425
Height (in)	61	71 ½	71 ½
Length (in)	101	120	138
Width (in)	51	55	55
Wet Weight (lb)	4,200	5,000	7,000
Performance Curve	A	B	C

Capable of achieving higher flow rates using less horsepower.



Performance curves

- A** GRL150
- B** GRL200
- C** GRL300

Composite curves for comparison purposes only. Consult engineering data for exact flow and head capabilities.

* Curves reflect pump speed.

GRL150 engine speed is 3.85x pump speed.

GRL200 engine speed is 3.75x pump speed.

GRL300 engine speed is 3.66x pump speed.

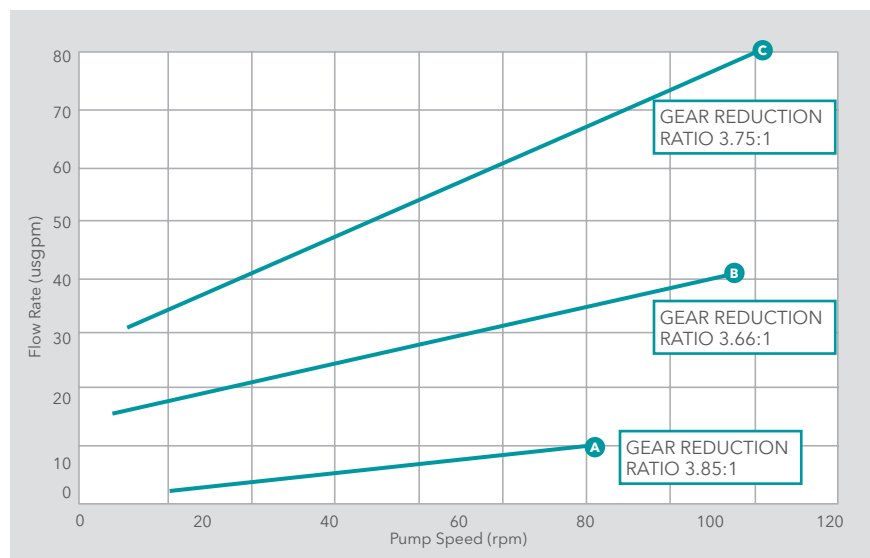

Godwin Wet-Prime Pumps

Dewatering

Godwin Wet-Prime Dewatering pumps are suitable for pumping water with light abrasives and small solids, found in applications including semi-trash construction and industrial dewatering, landscaping and irrigation, utilities, manholes and vault draining.

Trash

Godwin Wet-Prime Trash pumps are suitable for construction and industrial applications including trash-laden water, stream/pond dewatering, septic tanks and manholes and pumping water with light abrasives and solids.





Pressure

Godwin Wet-Prime Pressure pumps are suitable for marine construction, remote firefighting, landscaping, irrigation, tank cleaning and jetting.

Plastic

Godwin Wet-Prime Plastic pumps are suitable for agricultural chemicals, general dewatering, landscaping, irrigation, saltwater dewatering, and swimming pools.



	Dewatering			
	GWP-25HX	GWP-50HX	GWP-80HX	GWP-100HX
				
Suct./Disch. Dia. (in)	1	2	3	4
Solids Handling Dia. (in)	1/8	3/8	3/4	1
Max Total Dynamic Head (ft)	106	95	85	92
Flow (gpm)	30	158	238	383
Power (HP)	1.1	4.0	5.5	8.0
Fuel Tank Cap. (gal)	0.15	0.66	0.95	1.58
Dimensions (in)	9x14x13	18x14x15	20x15x17	26x20x26
Weight (lbs)	12.1	51	64	123

DEWATERING PUMPS PERFORMANCE CURVE

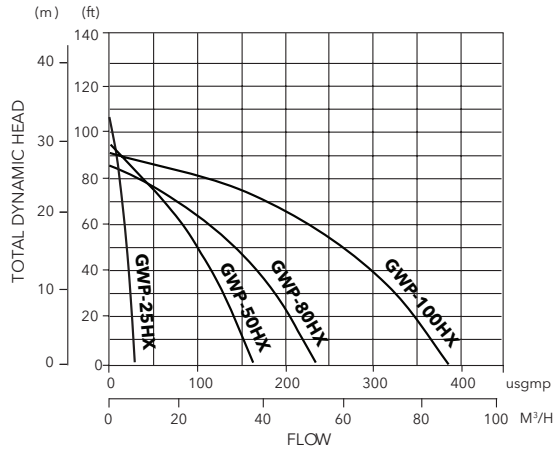

TRASH PUMPS PERFORMANCE CURVE

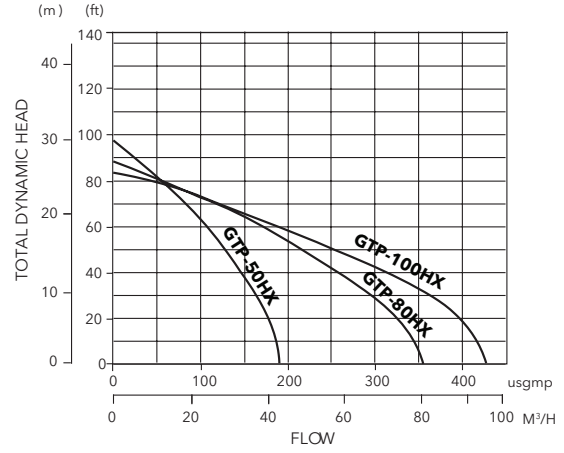



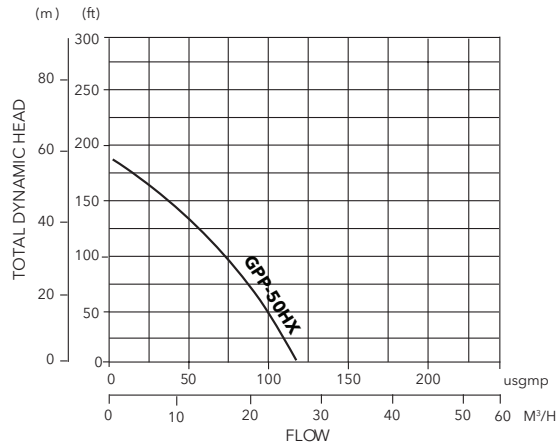

PRESSURE PUMP PERFORMANCE CURVE

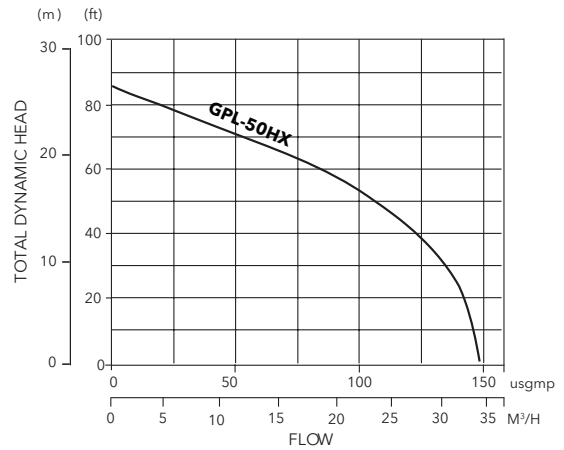

PLASTIC PUMP PERFORMANCE CURVE



Trash			Pressure	Plastic
GTP-50HX	GTP-80HX	GTP-100HX	GPP-50HX	GPL-50HX
				
2	3	4	2	2
1	1 ½	2	½	½
98	89	82	187	85
185	354	425	116	148
5.5	8.0	11.0	5.5	4.0
0.95	1.58	1.72	0.95	0.45
24x18x19	27x19x22	30x28x28	20x15x17	20x15x16
104	128	172	71	46

Monitoring & Control Equipment

Automated Controls

Godwin pumps feature industry-leading pump controls and monitoring equipment, in response to factors such as emissions and noise regulations, pump efficiency and longevity, and power/fuel efficiency.

PrimeGuard™ 2 Controller

The Godwin PrimeGuard 2 Controller is a fully programmable microprocessor engine control system allowing for inputs from level, pressure or flow transducers or standard floats. Using any of these systems, a Godwin Dri-Prime pump can start and stop automatically with no operator intervention required.

PrimeGuard 2 Controller



Field Smart Technology (FST)

With Godwin's remote monitoring and control offering, Field Smart Technology (FST), engine and pump data is collected in one-minute intervals through cellular signal or satellite connection. This data, as well as the ability to start and stop the pump, is available on a private website accessible anywhere, which allows for better use of labor and resources.

Field Smart Technology (FST)



Industrial Grade Controls for Electric Pumps

MANUAL CONTROL PANEL

This panel is our basic offering for manually controlling an electric pump with no remote capability. This means it is available at a much lower cost than other starters.

AUTOMATIC CONTROL PANEL

This panel offers automatic control by any pair of normally open contacts (floats, relays, pressure switch and remote switch).

VFD

The variable frequency drive (VFD) is the ultimate electric pump controller. It has all the features of our other controllers, while also allowing the speed of the pump to vary to achieve a specific duty point.

Variable Frequency Drive (VFD)



	Manual CP	Auto CP	VFD
	Circuit breaker only	Circuit breaker and contactor	Circuit breaker and VFD
Remote Capability	NO	YES	YES
Recommended HP Range	up to 60HP	up to 200HP	20-400HP
Enclosure	NEMA 3R	NEMA 3R	NEMA 3R
Motor Speed	60hz	60hz	0hz to 60hz to 120hz
Rate and Type of Speed	Instant, Fixed	Instant, Fixed	Ramped, Variable
Auto Speed Adjustment	NO	NO	YES

Godwin Light Towers

Godwin Light Towers are powerful enough to cover 5 to 7 acres, yet portable enough to be manned by one person.

- Start limit main breaker prevents start up under a load
- 14-gauge steel, tubular frame provides structural reliability in a variety of conditions
- Manually-deployed, 30' tall, 360° rotating steel mast projects 4000W of adjustable light to illuminate up to 5-7 acres
- Four-point outrigger stance withstands 65+ mph winds
- Automatic shutdown triggered by low oil or high temperature
- 30-gallon fuel tank with consumption rate of approximately 0.5 GPH for an estimated run time of 60 hours



Model GLT416

Generator	4-pole, brushless, self-regulated 6,000 W
Fuel Tank	30 gal
Mast & Card	30' maximum extension, coiled
Lights	Four 1000 W metal halide
Ballast Type	Coil and core
Lumens	440,000
Coverage	5-7 acres

Godwin Power Generators

Generators provide power for electric pumps, as well as for light towers so work can continue day and night.

Our generators are sturdy and have an optimized design to work seamlessly with our range of electric driven pumps.

	GHP20kW-R	GHP26kW-R	GHP35kW-R	GHP45kW-R	GHP60kW-R	GHP65kW-R	GHP80kW-R
POWER OUTPUT							
Three Phase - Prime (kW)	23	27	34	46	59	67	80
Amps 480V Prime Rating	35	41	52	69	89	101	120
Amps 480V Standby Rating	38	45	57	77	99	112	132
Single Phase - Prime kW	22	26	33	45	56	62	72
Amps 240V	92	108	138	188	233	258	300
AC DISTRIBUTION							
Main Breaker Amps	125	125	200	225	300	300	400
Voltage Selection	3 Position Padlockable Switch	3 Position Padlockable Switch	3 Position Padlockable Switch	3 Position Padlockable Switch	3 Position Padlockable Switch	3 Position Padlockable Switch	3 Position Padlockable Switch
ENGINE							
HP @ Prime @1800 (rpm)	36.2	43	53	72	91	102	122
Fuel Tank Volume gal	100	66	106	113	147	147	147
Fuel Consumed Prime (gal/hr)	2.1	2.6	3.0	4.0	5.6	5.6	6.2
Approximate Run Time hrs @ Prime	43	25.00	32.00	25.00	24.00	24.00	22.00
SIZE & WEIGHT							
Skid Mounted L x W x H (in)	95 x 39 x 65	83X35X52	95X35X56	95x35x56	96x38x62	96x38x62	96x38x62
Dry Weight (lbs)	2,430	2,074	2,537	2,415	3,438	3,563	3,549
OPTIONAL TRAILER							
Trailer Mounted L x W x H (in)	152x58x83	150x57x67	143x57x72	143x57x72	158x60x84	158x60x84	158x60x84
Dry Weight (lbs)	2,950	2,594	3,057	2,930	4,173	4,298	4,248



GHP100kW-R	GHP115kW-R	GHP140kW-R	GHP150kW-R	GHP185kW-R	GHP250kW-R	GHP255kW-R	GHP325kW-R
97	119	144	152	190	233	256	327
146	179	217	229	285	350	385	492
161	197	238	251	315	386	425	539
95	117	142	150	-	-	-	-
396	488	592	625	-	-	-	-
450	600	700	700	800	1,200	1,200	1,600
3 Position Padlockable Switch	3 Position Padlockable Switch	3 Position Padlockable Switch	3 Position Padlockable Switch	Link / Reconnect Board	Link / Reconnect Board	Link / Reconnect Board	Link / Reconnect Board
150	180	216	228	286	353	422	489
342	342	342	342	360	480	480	616
7.7	9.8	10.9	11.0	15.2	16.9	17.9	21.1
40.00	32.00	29.00	28.00	21.00	26.00	24.00	27.00
132x50x73	132x50x77	132x50x77	132x50x77	132x50x77	156x60x90	156x60x90	175x60x96
6,206	6,409	6,765	6,765	7,330	8,860	8,860	1,275
210x86x90	210x86x93	210x86x93	210x86x93	210x86x93	231x102x110	231x102x126	250x102x116
7,602	7,805	8,705	8,705	9,270	10,860	11,763	16,000

* Generators listed are available for rental. For additional sale models, contact the factory.

Godwin Genuine Spare Parts Kits

We offer a full range of parts for all of our equipment that we can either deliver directly to you or send along with a technician to do the repair work for you. Our service and sales staff is on call 24/7 to meet your needs whenever and wherever they occur.

Dri-Prime® 1-2 Years Parts Kit

Available for diesel engine driven and electric motor driven Dri-Prime pumps, each kit includes:

- Venturi jet and nozzle
- Compressor line
- Belt
- O-rings
- Discharge ball/seat or flapper/gasket
- Inspection gaskets
- PDF drawing illustrating the location of each part



Dri-Prime Diesel Engine Filter Kit

Available for Tier 2, Tier 3, IT4 and T4 engines, each kit contains:

- Oil filter
- Fuel filter(s)
- Air filter(s)
- Compressor filter (if applicable)



Dri-Prime Mechanical Seal Kit

Available for diesel engine driven and electric motor driven Dri-Prime pumps, each kit contains:

- Viton/ss gaskets to work with standard or stainless units.
- All components needed to replace mechanical seal with one part number and one kit.



Accessories



High Density Polyethylene Pipe (HDPE) – 4"-36"

Thousands of feet available for immediate rental or sale.
Fittings and adapters available for complete system installation.



Fusion Machines

Self-contained for on-site polyethylene pipe fusion and installation.
Capable of fusing diameters up to 36 inches.

Expert fusion technicians available as operators.



Godwin Quick Disconnect Pipe

Unique pipe and adapter quick disconnect (QD) coupling system for discharge hose and pipe. Strong and durable yet lightweight, Godwin Quick Disconnect Pipe is produced from high tensile strength abrasion-resistant steel that is hot-dipped galvanized, offers deflection at each joint up to 30°, and is available in 3, 6, 10, and 20 foot lengths.



Road Ramps

If piping needs to cross a road, these easy-to-use road ramps will keep the traffic moving. Godwin road ramps provide a temporary crossing for low-volume traffic in industrial, mining, commercial and residential areas where vehicle access over a pipeline is required. For use with 4, 6, 8, 12, 18 and 24 inch pipe.



Pipe and Sewer Plugs

Tough inflatable plugs for total stoppage in sewer bypass applications in sizes from 5 to 60 inches.

Rugged, multi-purpose rubber pipeline plugs with metal end caps available in sizes from 4 to 30 inches with no-flow and flow-thru designs.

Fill kits available for all sizes. Tough rubber plugs resistant to tears and punctures, yet easy to install and inflate.

Godwin Hose

A Complete Range to Fit Any Application

Standard hose lengths are 10' and 20'. Custom lengths are available on request.



SUCTION HOSE - 1"-12", BLACK RUBBER. FOR WATER, OIL AND SEWAGE APPLICATIONS

Godwin setups often utilize heavy duty suction hoses, fully vacuum rated 1"-12" diameters. Available with easy-to-use Godwin Quick Disconnect or cam and groove fittings or flanges.



DISCHARGE HOSE - 2"-12" GODWIN ORANGE HOSE AVAILABLE IN COLLAPSIBLE LAYFLAT OR FLANGED HIGH PRESSURE

High pressure layflat discharge hose is rugged, oil resistant hose built for the rental industry. Available with Godwin Quick Disconnect or cam and groove fittings, with double bolt clamps for open discharge and medium pressure applications.

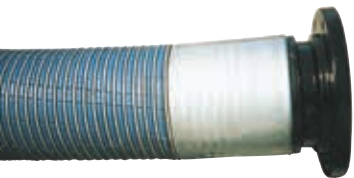

COMPOSITE OS&D HOSE

When high pressure and flexible are a prerequisite, 150 lb flanged high pressure hose is the hose of choice. Capable of full vacuum rating and pressure to 200 psi, for use in water and petroleum applications.



PVC LAYFLAT HOSE

Heavy-duty discharge hose available in 2"-8" diameters and 50' lengths with premium quality PVC tube and cover suitable for agriculture, quarry, irrigation, mining, construction and industrial applications.

BULL AIR HOSE (WITH HIGH PRESSURE GROUND JOINT FITTINGS)

Heavy-duty, steel wire air hose 2"-4" in diameter, 50' lengths with SBR cover for use in mines, quarries, construction and industrial.



CARGO OS&D HOSE

Rugged, high pressure psi rated hose with 150 lb or 300 lb flanges is used for water, oil, petroleum, sewage and sludge applications.



LIGHT WEIGHT ORANGE HELIX HOSE

Extremely lightweight and rated for full vacuum as well as pressure. Available with Godwin Quick Disconnect or cam and groove fittings. Perfect for applications where flexibility and light weight are required.



XLPE CHEMICAL HOSE

Cross Link Polyethylene hose with stainless steel cam and groove fittings is suitable for chemical applications in low or high pH conditions.



STAINLESS STEEL BRAIDED HOSE

High temperature, high pressure stainless steel braided hose available in 2"-6" diameters provides flexibility and durability fit for most metal hose applications.



AIR HOSE

200 psi-rated synthetic rubber air hose with spiraled reinforced cord for a wide range of industrial and construction applications.



Quick Disconnect Couplings & Adapters



FLANGED ENDS

	Flanged end x male ball & lever	Flanged x female
Sizes (in)	2, 3, 4, 6, 8, 10, 12	2, 3, 4, 6, 8, 10, 12

SCREW ENDS

	Male NPT threaded end by male ball end	Male NPT threaded end by socket	S-Bend (Step Bow)
Sizes (in)	2, 3, 4, 6, 8, 10, 12	2, 3, 4, 6, 8	3, 4, 6, 8



STRAINERS

	Low profile screen x male (w/ closure ring)	Round small hole screen x male (w/ closure ring)	Large hole screen x male (w/ closure ring)
Sizes (in)	2, 3, 4, 6, 8	2, 3, 4, 6, 8	2, 3, 4, 6, 8

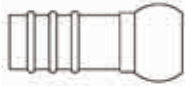
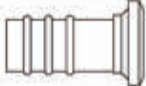

PIPE BENDS

	90° elbow	60° elbow	45° elbow	90° elbow x flange
Sizes (in)	2, 3, 4, 6, 8, 10, 12	2, 4, 6, 8	2, 6, 8	4, 6, 8

HOSE ENDS

	<p>Hose shank x ball (male)</p> 	<p>Hose shank x socket (female)</p> 	<p>Lever closure ring</p> 
Sizes (in)	2, 3, 4, 6, 8, 10, 12	2, 3, 4, 6, 8, 10, 12	2, 3, 4, 6, 8

ADAPTORS

	<p>Reducer</p> 	<p>Increaser</p> 
Sizes (in)	3x2, 4x3, 6x4, 8x6, 10x8, 12x10	2x3, 4x3, 6x4, 8x6, 10x8, 12x10

TEE AND Y ADAPTERS

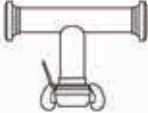
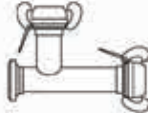
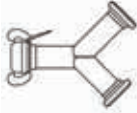
	<p>End Tee male x male x female</p> 	<p>Outlet Tee female x female x male</p> 	<p>Line Tee male x female x male</p> 	<p>Y Adapter female x female x male</p> 
Sizes (in)	2, 3, 4, 6, 8, 10, 12	3, 4, 6, 8	2, 3, 4, 6, 8, 10, 12	2, 3, 4, 6, 8, 10, 12

SEALING RINGS

	<p>Rubber sealing ring</p> 	<p>Oil Resistant rubber sealing ring</p> 
Sizes (in)	2, 3, 4, 6, 8, 10, 12	2, 3, 4, 6, 8

Xylem |'zīləm|

- 1) The tissue in plants that brings water upward from the roots;
- 2) a leading global water technology company.

We're a global team unified in a common purpose: creating innovative solutions to meet our world's water needs. Developing new technologies that will improve the way water is used, conserved, and re-used in the future is central to our work. We move, treat, analyze, and return water to the environment, and we help people use water efficiently, in their homes, buildings, factories and farms. In more than 150 countries, we have strong, long-standing relationships with customers who know us for our powerful combination of leading product brands and applications expertise, backed by a legacy of innovation.

For more information on how Xylem can help you, go to www.xylem.com/dewatering



Bridgeport, NJ
Telephone +1 (856) 467-3636

Godwin is a brand of Xylem. For the latest version of this document, more information about Godwin products and the nearest office location or distributor near you visit **www.godwinpumps.com**